



EDIT

NC program editing, simulation
and machine communication



INTRODUCTION

What is CIMCO Edit?

Built for CNC programmers who demand a full-featured and reliable editing and communication tool

CIMCO Edit comes with all the essential features needed for modern NC program editing including NC specific functions, math, transforms, drag/drop editing and more. In addition, CIMCO Edit includes file compare, mill/turn backplotter, advanced Tool Manager, NC code assistant and offers powerful add-ons for machine simulation, program management, 2D CAD/CAM, and more.

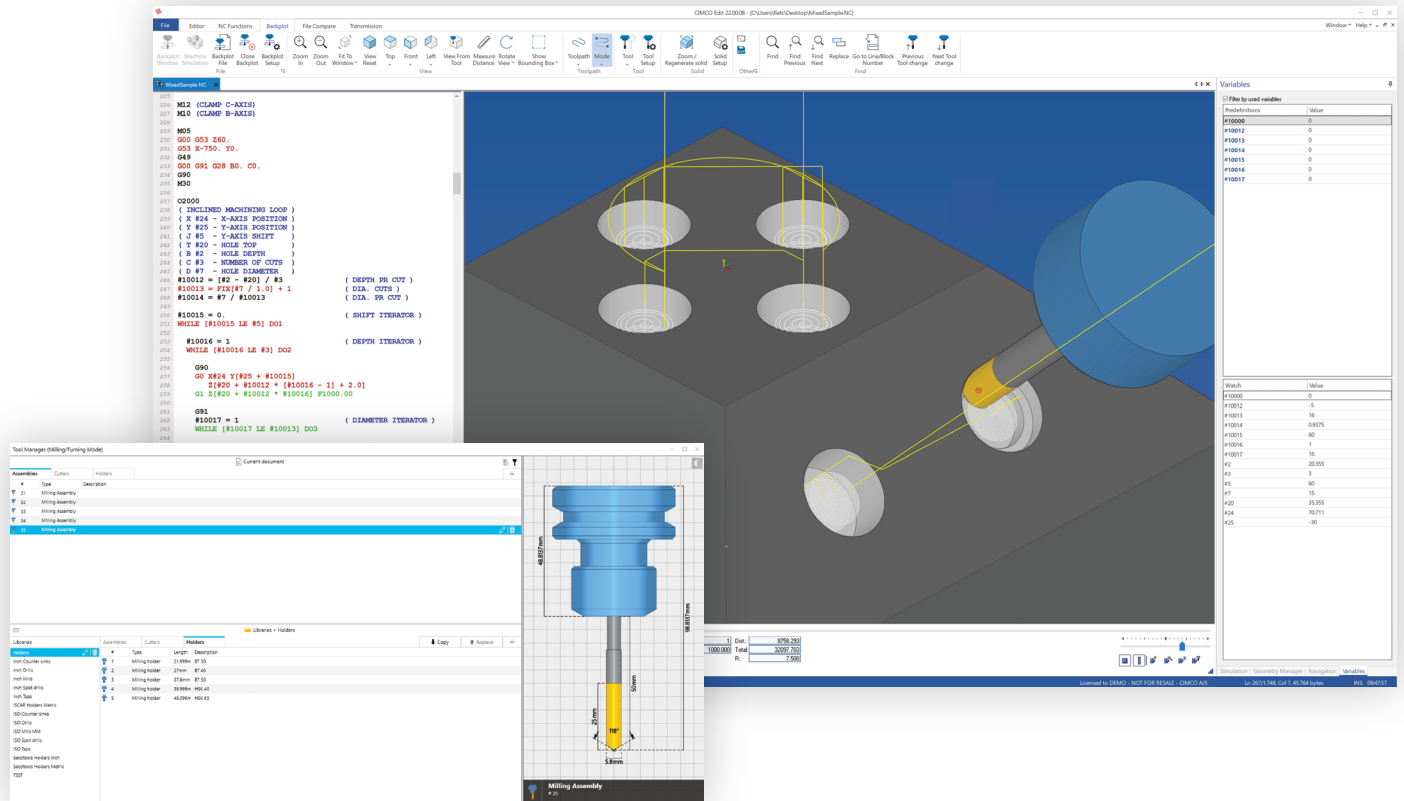

BENEFITS

Why use CIMCO Edit?

Faster editing at PC

Work with NC programs on your PC, in a familiar Windows-based application instead of on complicated machine controls.

Error-free code

Use code suggestions, syntax checking and error reports to help you write error-free NC code.

Work smarter

Define associated objects such as workpiece, tools and holders directly in your NC programs for 1-click setup when simulating.

Better Tool Management

Easily view and modify tools in your NC program for fast, iterative testing and simulation.

Transfers to/from machine

Manage program transfers to and from machines with reliable and configurable DNC RS-232 and FTP communications support.

Scalable and integrated

Proven in thousands of shops worldwide, powerful add-ons, and built for integration with external systems.

FEATURES

What is included?

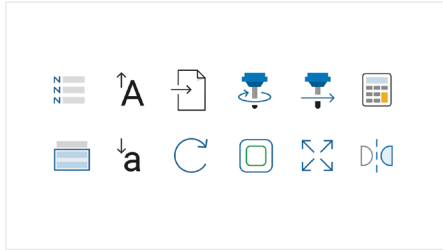

Essential editing tools

Comprehensive set of editing tools including line numbering, character handling, XYZ range finder, tool compensation, basic math, and more.

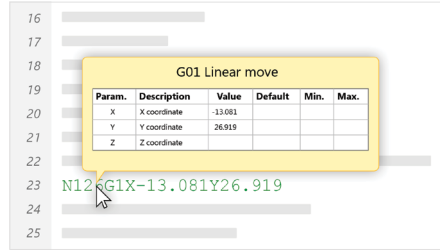

NC-Assistant

Point at any M or G code and the NC-Assistant will identify the code and allow you to modify its values using an interactive interface.

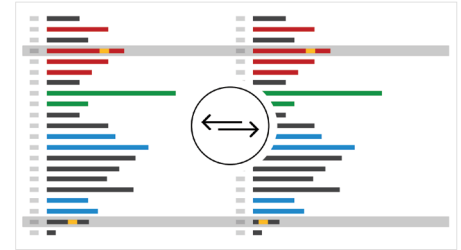

File Compare

The file compare identifies new, changed and deleted lines, but ignores trivial format changes such as block renumbering and spacing.

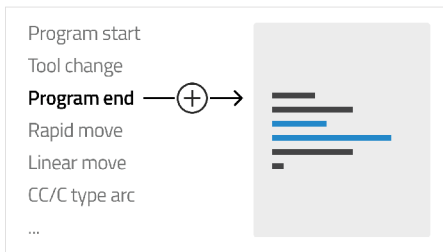

Cycles and Macros

Quickly insert and edit cycles and operations or record your own for the operations most common to your setup. Includes many built-in cycles and macros.

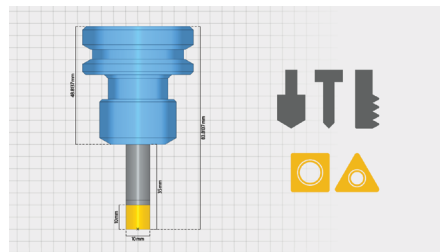

Tool Manager

Easily view and modify the tools in your NC program. Simply copy/replace tools from your library to your active tool list and vice versa. Hundreds of predefined tools and holders.

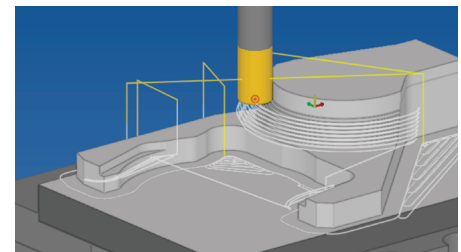

Backplot/Solid Simulation

Simulate your NC programs in 3D with the 3-5 axis milling and turning backplotter. High-resolution simulation of stock removal, collision checking, gouge detection and more.

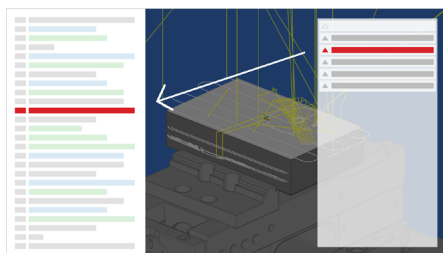

Simulation Report

All program errors are shown in the Simulation Report. Select an error and jump to the corresponding line. Modify the code and the Simulation Report verifies that the problem is resolved.

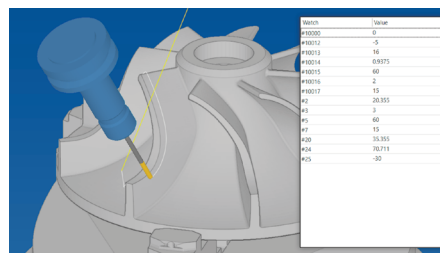

Variable Watch

Track the initial and current state of variables in your NC program while the simulation is running or when selecting specific lines.

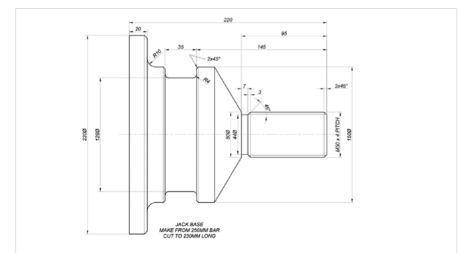

Free online courses

A great introduction to CIMCO Edit. Our online training courses teaches you milling and turning, trigonometry, NC code, and much more.

- ✓ **Navigation**
Auto-generate an operation structure from your NC code.
- ✓ **Scanning Commands**
Automate the loading of tools, geometry, work offsets, stock, and more.
- ✓ **Geometry Manager**
Tree view for overview and configuration of machine components.
- ✓ **CAM Integrations**
Transfer data from supported CAM systems (Mastercam, SolidCAM).

MORE

www.cimco.com →

Visit our website to discover many more features, videos or to download our free, 30 day trial version of CIMCO Edit.



CIMCO is a leading developer of software and solutions for Computer Integrated Manufacturing including advanced CNC-Editors, DNC software for reliable CNC communication, Manufacturing Data Collection for real-time monitoring and analysis of shop floor productivity, and Manufacturing Data Management for managing, organizing and securely storing production related data.

Since 1991, CIMCO has helped companies worldwide improve their competitive edge by providing reliable software and outstanding on-site assistance. Our network of CAD/CAM/CNC resellers and consultants have sold more than 100,000 licenses worldwide and we hold great pride in continuously supporting and meeting our customers' demands by developing intelligent and competitive solutions.

MICROSOFT, MICROSOFT OFFICE, MICROSOFT EXCEL AND OTHER MICROSOFT PRODUCTS ARE REGISTERED TRADEMARKS OF MICROSOFT, INC. FURTHERMORE, CIMCO MDM DOES NOT INCLUDE A LICENSE FOR MICROSOFT OFFICE. IN ORDER TO OPEN FILES EXPORTED IN XLSX OR XLS FORMAT, A LICENSE OF MICROSOFT EXCEL MUST BE PURCHASED SEPARATELY FROM MICROSOFT, INC.

MAIN OFFICES

DENMARK CIMCO A/S
VERMUNDSGADE 38A
COPENHAGEN, DENMARK

AMERICAS CIMCO AMERICAS LLC
7341 OFFICE PARK PLACE #202
MELBOURNE, FL 32940

TEL: +45 45 85 60 50
FAX: +45 45 85 60 53
EMAIL: info@cimco.com

TEL: +1 704 644 3587
FAX: +1 704 943 0514
EMAIL: info@cimco.com

CIMCO HEADQUARTERS AND MAIN TRAINING FACILITY ARE LOCATED IN THE DANISH CAPITAL COPENHAGEN. THIS IS THE BASE OF OPERATION FOR THE SALES AND SUPPORT TEAM. OUR TECHNICAL SERVICE STAFF TRAVELS WORLDWIDE AND HAS LOCAL OFFICES IN SELECT COUNTRIES.

LOCAL OFFICES / RESELLERS WORLDWIDE

EUROPE

AUSTRIA	FINLAND	NETHERLANDS	SLOVAKIA
BELARUS	FRANCE	NORWAY	SLOVENIA
BELGIUM	GERMANY	POLAND	SPAIN
BULGARIA	HUNGARY	PORTUGAL	SWEDEN
CROATIA	IRELAND	ROMANIA	SWITZERLAND
CZECH REPUBLIC	ISRAEL	RUSSIA	TURKEY
DENMARK	ITALY	SCOTLAND	UKRAINE
ESTONIA	LATVIA	SERBIA AND MONTENEGRO	UNITED KINGDOM

SOUTH / NORTH AMERICA

BRAZIL	USA
CANADA	VENEZUELA
CHILE	
COLOMBIA	
COSTA RICA	
ECUADOR	
MEXICO	
PERU	

ASIA / MIDDLE EAST / OCEANIA

AUSTRALIA	SINGAPORE
CHINA	SOUTH AFRICA
HONG KONG	SOUTH KOREA
INDIA	TAIWAN
INDONESIA	THAILAND
JAPAN	UNITED ARAB EMIRATES
MALAYSIA	VIETNAM
NEW ZEALAND	

 CIMCO AUTHORIZED RESELLER



More information at
www.cimco.com



Watch our product videos at
[/cimcoveideo](https://www.youtube.com/c/cimcoveideo)



Follow on Facebook
[/cimco](https://www.facebook.com/cimco)



Follow on LinkedIn
[/company/cimco-a-s](https://www.linkedin.com/company/cimco-a-s)